

# AAMBIVERT Concept Statement

By Amalia Adela Samoila

Aambivert is a dystopian and cyberpunk inspired clothing capsule collection with pieces can be worn either combined or individually as accessories. The colour palette is a blend of neutral sand tones while the silhouette is focus on body armour, tactical gear, protective wear and compression pads. Based on the concept of a video game where you get to create your own avatar the brand is trying to empower people to embrace thier individuality and express themselves through clothing and accessorising. The collection give the audience the opportunity to mix and match the pieces from one outfit to another in order to crate endless possibilities of styling. The brand gives the wearer empowerment and confidence, hope of survival through good and bad, and bringing awareness about the future consequences if action is not taken by being more sustainable as designers and consumers. The clothing collection is made out of dead-stock leather, scrap materials, recycled plastic parts and other materials such as neoprene for a tight fit, 3d space mesh for air to flow, and waterproof twill canvas for extra protection and durability. Elements that it may be particularly attractive to individuals who are interested in science fiction, technology, and survivalism. Additionally, the brand emphasis on empowerment, confidence, and self-expression through clothing fact that may appeal to those who are interested in fashion as a means of personal expression. The brand brings awareness to important issues like empathy, technology and survival may also resonate with individuals who are concerned about the future of humanity and the world we live in. Overall is AAMBIVERT is for to people who are looking for something unique, thought-pravoking, empowering and also sustainable.

“CREATE YOUR AVATAR-CREATE YOUR BETTER REALITY”-AAMBIVERT





# BRAND NAME

Ambiverts are not afraid to take risks when it comes to fashion.

They are experimenting with different styles and trends, while mixing different patterns and textures in their outfits to create a unique, eye-catching look.

Their fashion sense reflects their adaptability and ability to blend in with different social situations, while still maintaining their individuality.

A  
M  
B  
I  
V  
E  
R  
T

CONCEPT

Start

DOYSTOPIAN  
CYBERPUNK

01

CEPT

001

RAMBIVERT

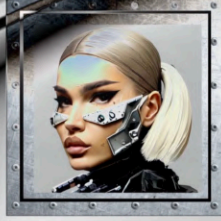

Choose your  
character

AI AVATAR  
GENERATOR

# Upgrade

Syncing

Syncing

ambivert\_001

Create  
Update  
Improve



# What is your Type

# Identity?

INTROVERT  
EXTROVERT  
AMBIVERT

AMBIVERT PROJECT



# DYSTOPIAN

RAMBIVERT

Extract: Rambivert archive

TEXTURES FEELINGS

# CYREDDI INK

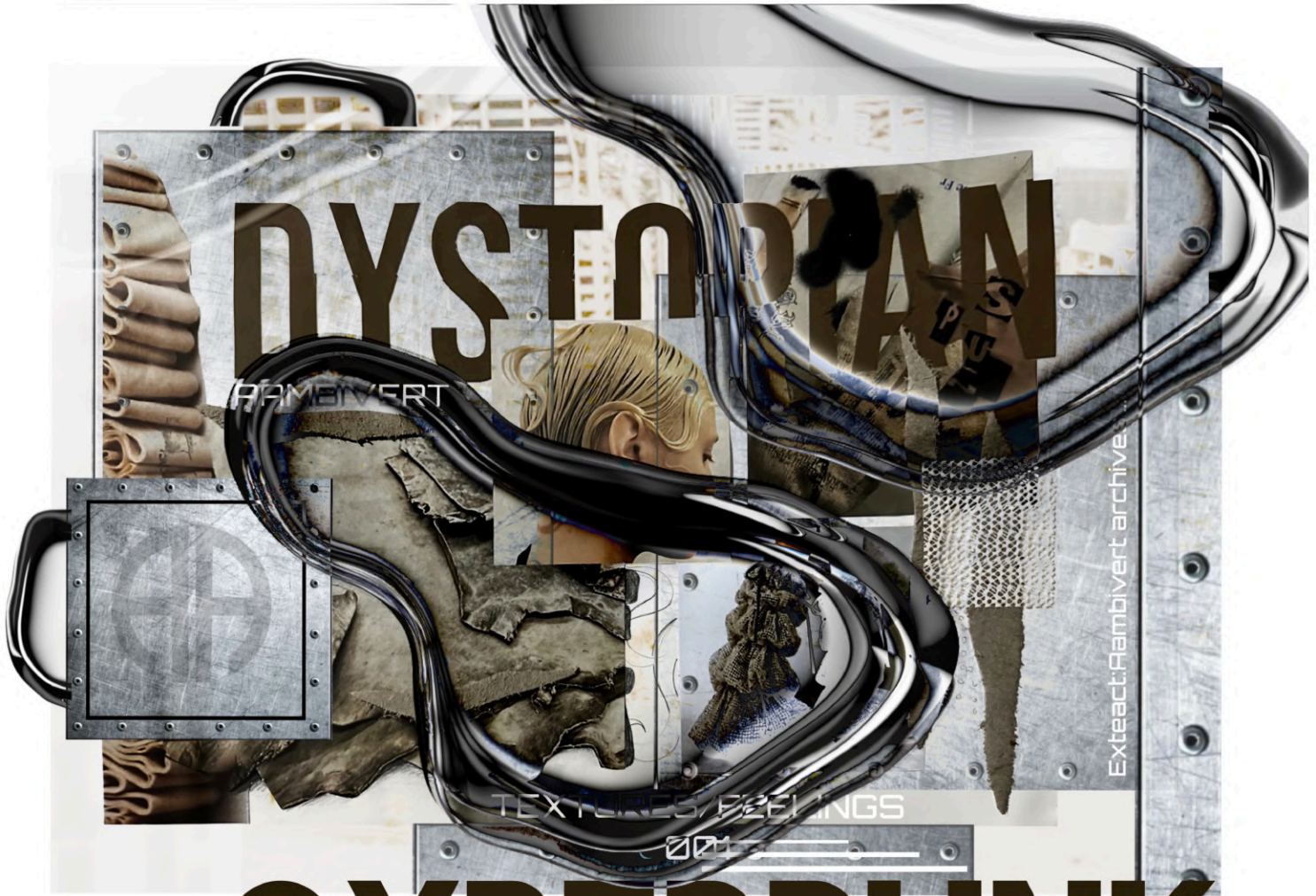





## AAMBIVERT market analysis

AAMBIVERT is an unique blend of dystopian and cyberpunk influences, combined with a focus on body armor, tactical gear, protective wear, and compression pads. Elements that it may be particularly attractive to individuals who are interested in science fiction, technology, and survivalism.

Additionally, the brand emphasis on empowerment, confidence, and self-expression through clothing fact that may appeal to those who are interested in fashion as a means of personal expression.

The brand brings awareness to important issues like empathy, technology, and survival may also resonate with individuals who are concerned about the future of humanity and the world we live in.

Overall is AAMBIVERT is for to people who are looking for something unique, thought-provoking, and empowering and also sustainable.

"CREATE YOUR AVATAR-CREATE YOUR BETTER  
REALITY"-AAMBIVERT



HELIOT\_EMIL

FUTURIST\_

6LACK.VIBE

Follow

MARKET Aesthetics

Deconstruction



Survival



Natural shapes

WHAT DO  
YOU FEEL?

Body armour

Source images:

RAMBIX VERT ARCHIVES

AI GENERATED PICTURES

MEIV





**AAMBIVERT?**

**WHAT IS THE NEXT MISSION ?**

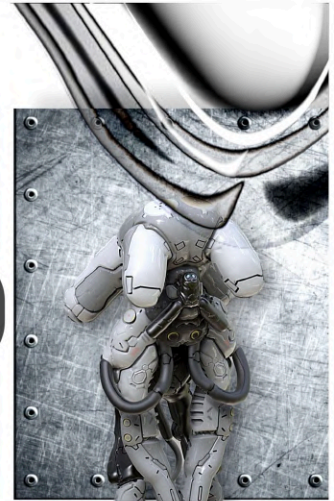

**MISSION.....**

**EMPOWER PEOPLE TO CREATE THEIR OWN PERSONA AND TO BECOME MORE AWARE OF THEIR SURROUNDINGS. FOCUSED ON FINDING SUSTAINABLE ALTERNATIVES TO REPLACE THE PROBLEMS WITH SOLUTIONS THROUGH EXPLORATION, INNOVATION AND CREATIVITY.**

**CREATE YOUR REAL-SELF, CREATE YOUR BETTER REALITY!**

**GLOBAL WARMING**

**CO<sub>2</sub> EMISSIONS**

**CLIMATE CHANGE**

**DEFORESTATIONS**



**MANIPULATION**

**PACK YOUR STUFF  
WE GOING TO WAR**

**HUMANS HAVE A SELF  
DESTRUCTIVE BEHAVIOUR**





APMBIVERT

DUSTY YELLOW  
12-0619 TCX

WINTER WHITE  
11-0507 TPX

WHISPER WHITE  
11-0701 TPX

BRIGHT WHITE  
11-0001 TCX

COLOR BOARD

PANTONE®



# FABRICS

Twill Canvas

Cow hide

3d Space Mesh

Neoprene

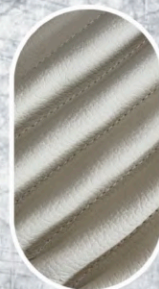

# FINISHES

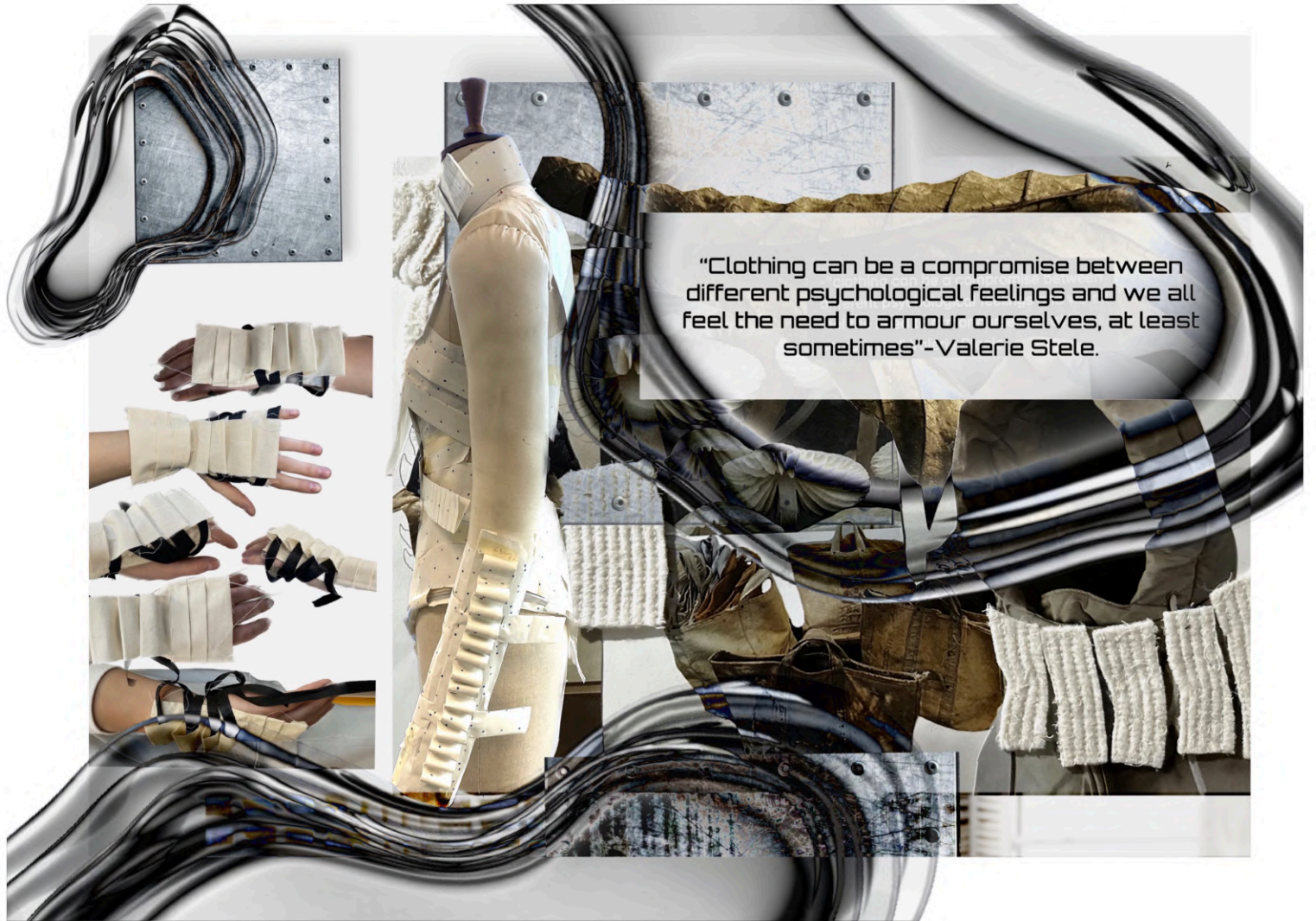

"Clothing can be a compromise between different psychological feelings and we all feel the need to armour ourselves, at least sometimes"-Valerie Steele.

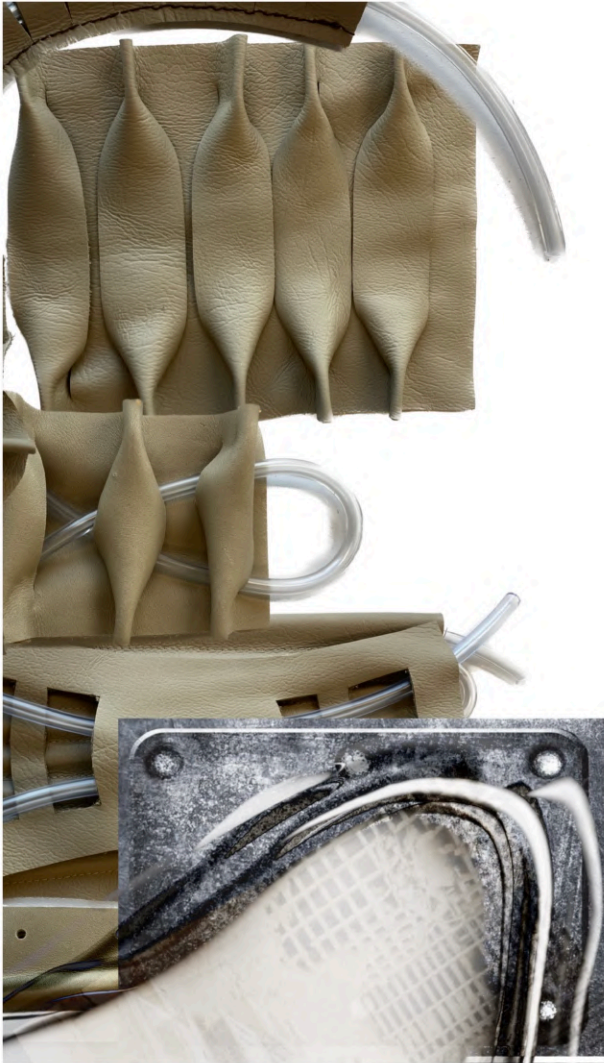

Leather  
manipulation  
samples

# AAMBIVERT

Design development



Leather experiments

Design development

Inspiration

Leather and calico experiments

Sampling on the stand



# Design Development

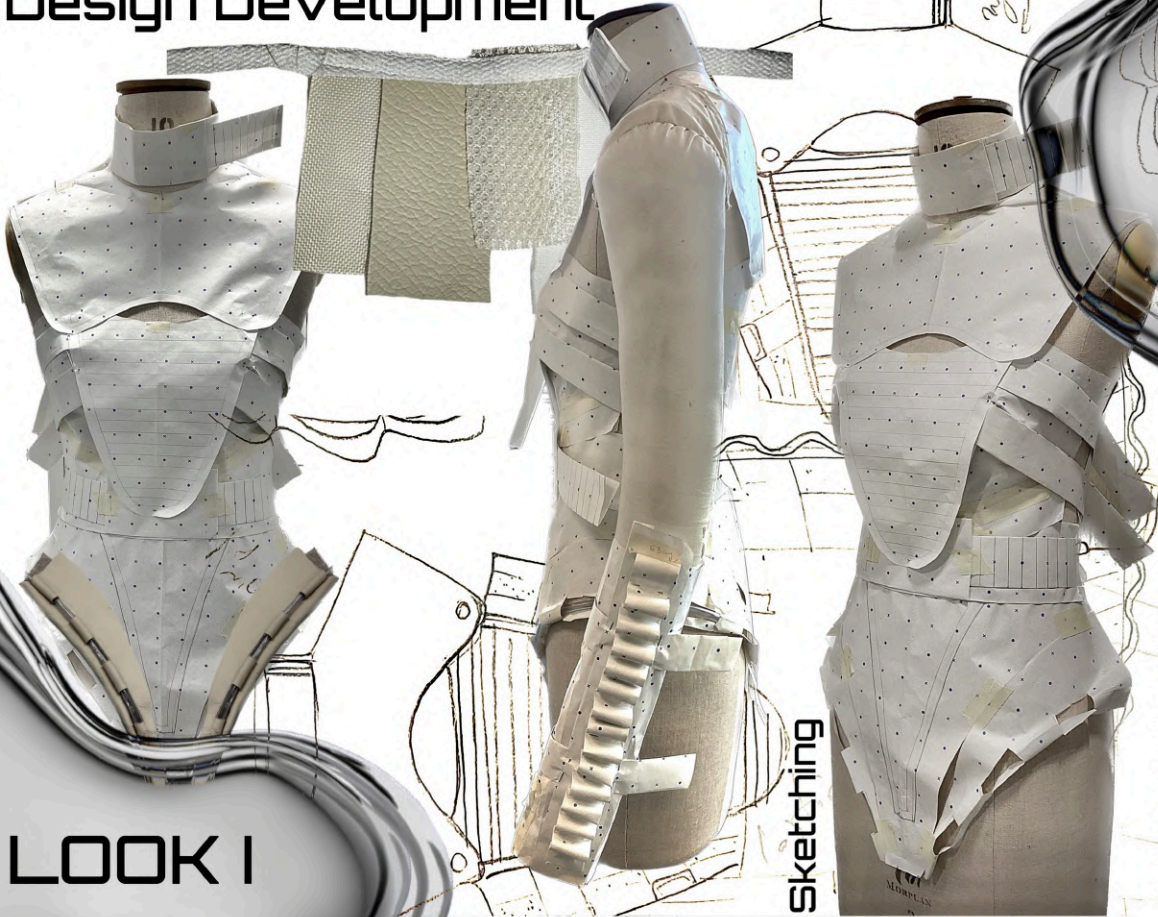

LOOK I

Sketching

Initial design idea

*nylon  
p.p.*



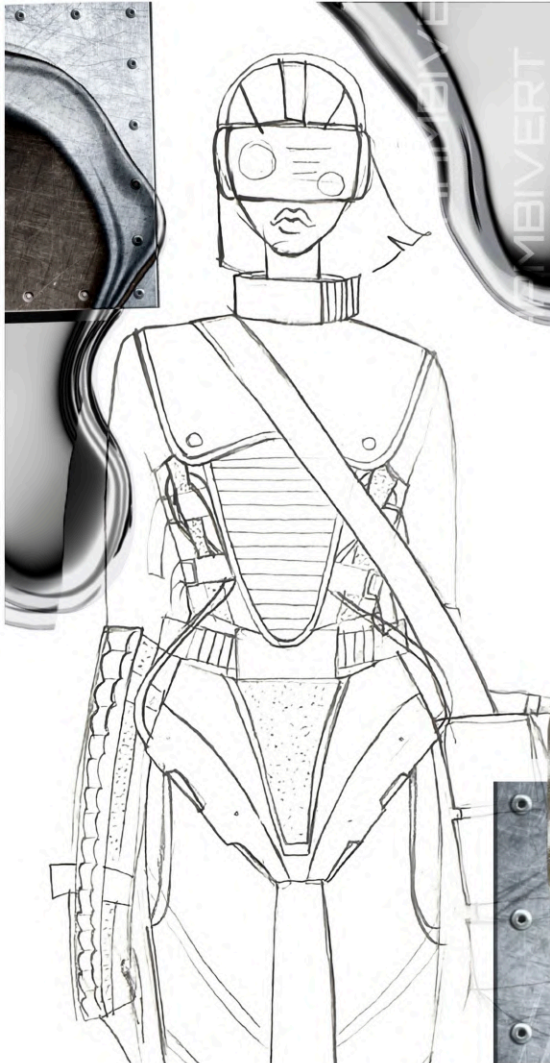

Sketching

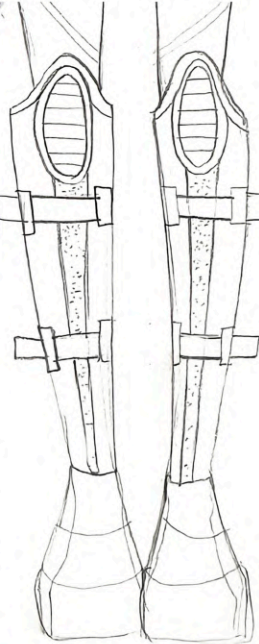

Inspired by fabric and leather manipulation experiments

LOOK 1

# LOOK 1

## FABRICS:

- cow hide
- waterproof twill canvas
- neoprene
- 3d power mesh

Design development

From toile to final





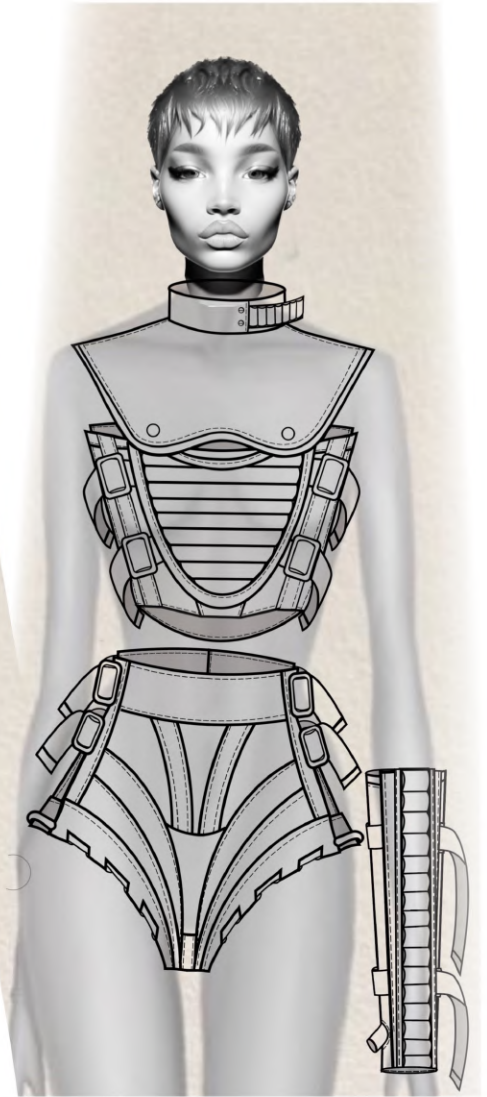
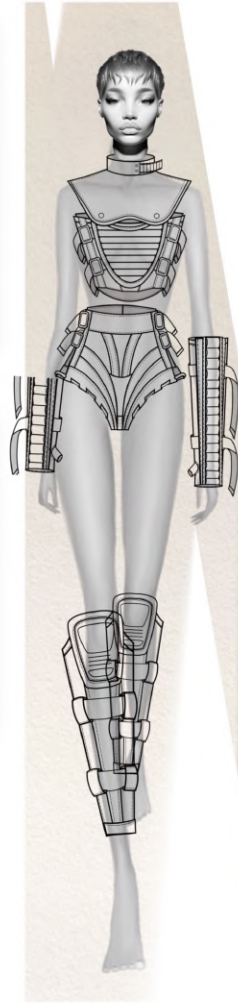
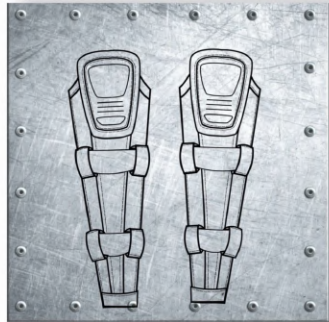
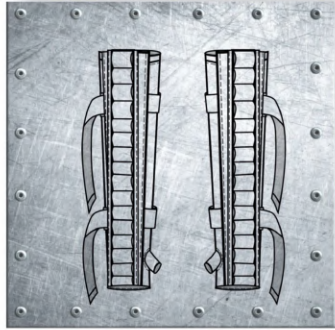
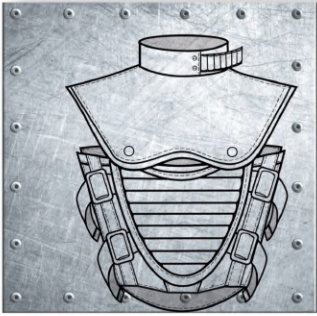

**LOOK I**

# LOOK I LEATHER ARMOUR CAD



# LOOK I LEATHER ARMOUR

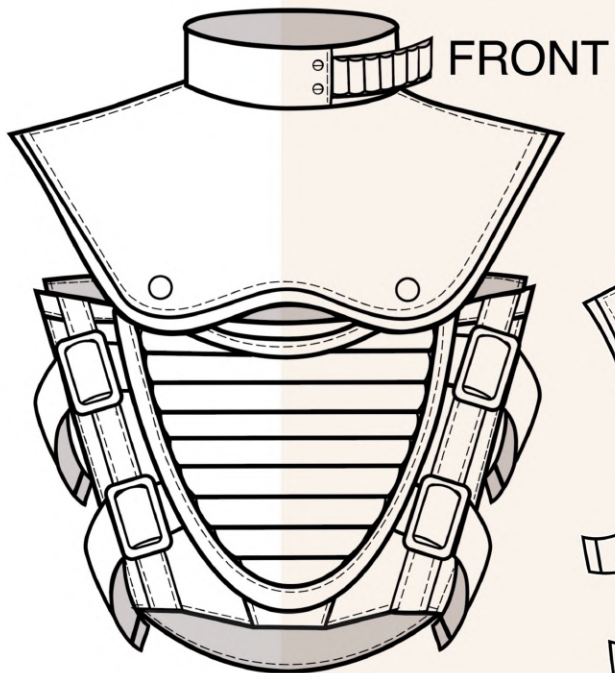

LOOK I ARMOUR



# LOOK I LEATHER ARMOUR CLO 3D DEVELOPMENT



**LOOK I LEATHER ARMOUR**

**REAL LEATHER.  
STAY DIFFERENT.**



WATERPROOF TWILL CANVAS

COW HIDE DEAD STOCK

3D MESH

NEOPRENE

LOOK 1

# RAMBIVERT

CYBERPUNK

DYSTOPIAN





RAMBIVERT  
001





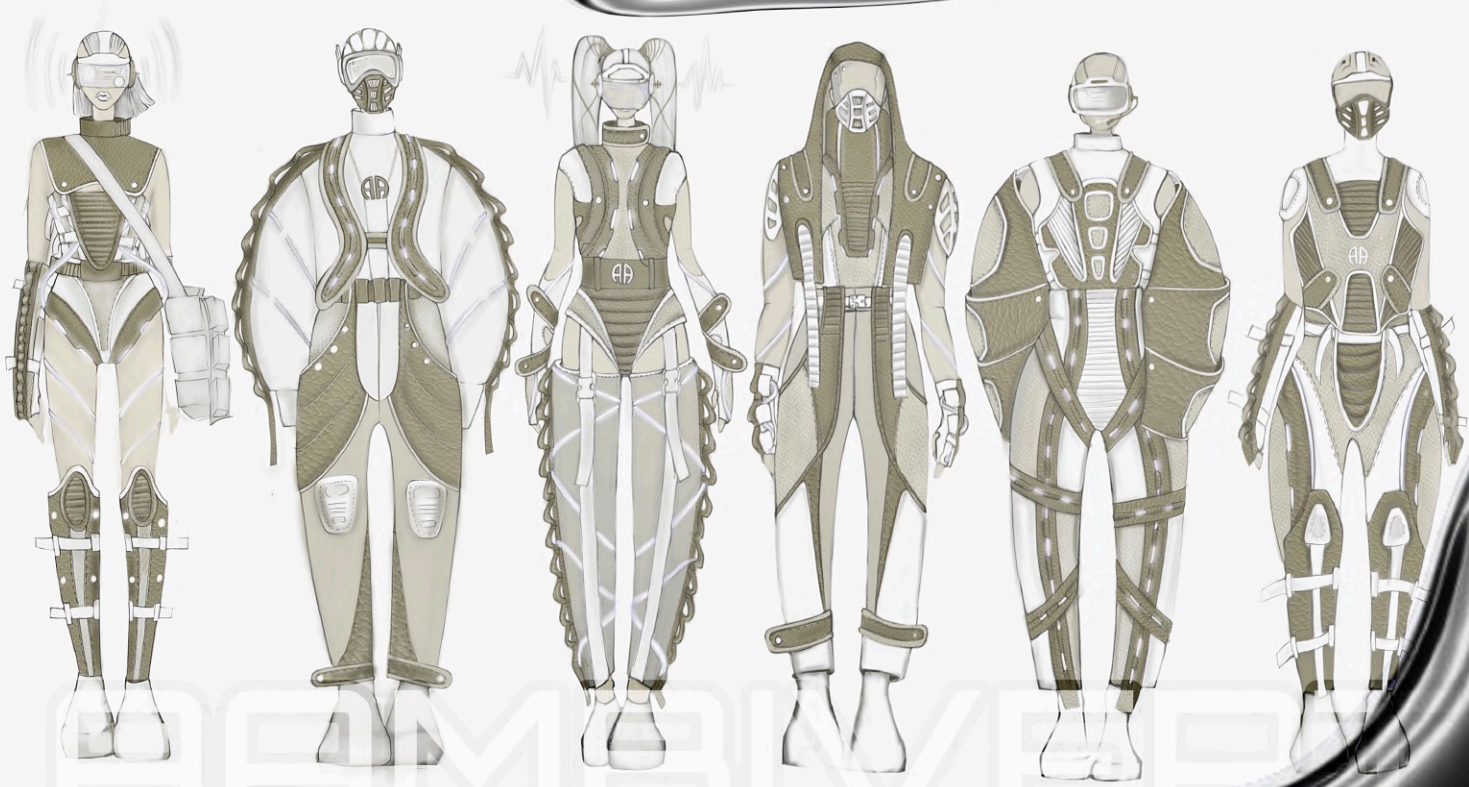

ARMORIVER