

**LINK THE PAST AND FUTURE**

**WOOSUNG KIM**  
**(BA) Footwear Design**

**sjg0229@gmail.com**  
**+44 (0) 7442637022**



**PAST**

WESTERN STYLE  
COWBOY

+



**FUTURE**

TECHNOLOGY  
SNEAKERS

This project aimed to combine 3 different elements and create the new footwear design DNA. The elements are Orienteering, Runway/Catwalk and Modularity.

From researching about orienteering, there was an interesting ironic combination between old and classic method and high technology equipment. I used this as my hybrid theme; Past + Future.

And I decided the western style as the past part. Because, with a renewed interest in all things vintage, cowboy boots re-entered fashion territory and have recently gained popularity among Gen Z consumers. And it has a lot of interesting components to be used.

The combination of technical shoes with western style can make a new outcome.

**MOOD BOARD**

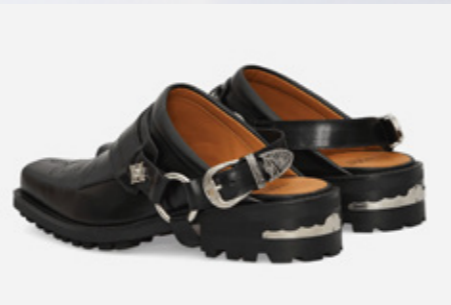

MODULARITY

COWBOY

TECHINCAL

GRASSLAND

02

## COLOUR PALLETE



PANTONE 2322

PANTONE 470 C

PANTONE 452 C

PANTONE 467 C

PANTONE 450 C

PANTONE 426 C



## CUSTOMER PROFILE

AGE : 18-35

GENDER : UNISEX

TRENDSETTER

INFLUENCER

FASHION LOVER

FAST FASHION

MASS MARKET

UNIQUE STYLE

## *Western style*

Rodeo inspired studs, embellished embroidery.



# INSPIRATION

## *Leg warmers*

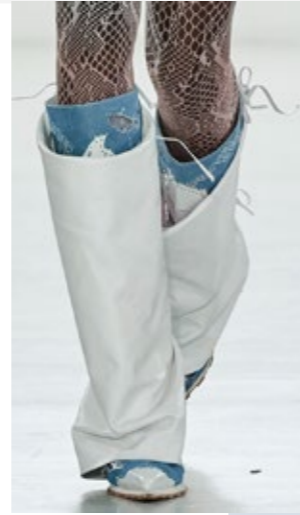

## Cowboy boots



Embroider



Antique Buckles



Narrow toe





## *Inspired by Cowboy boots*



*Thick heel*



*Narrow and sharp toe*



*Studs*



*Buckles*



*Harness*

# MARKET RESEARCH

## RUNWAY/CATWALK



Unique  
Creativity  
Art  
Culture  
Aesthetic  
Innovation  
Unconventional  
Distinctive  
Special



# MARKET RESEARCH

## RUNWAY/CATWALK FOOTWEAR



Conceptual  
Proportion  
Conventional Design  
Unique & Trend  
Unique Materials  
High Quality  
Technical Materials  
Hybrid Footwear  
Detailed



# Design Development 1



Classical leather sole from cowboy boots.

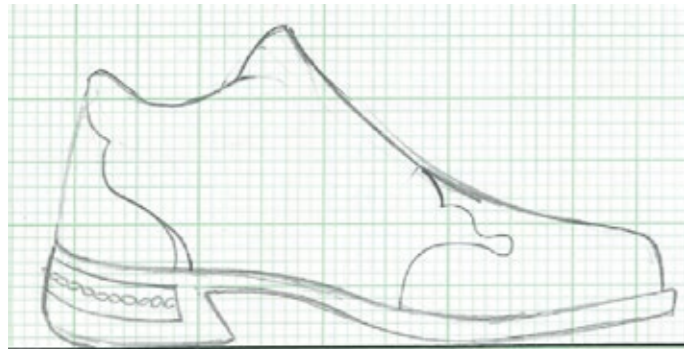
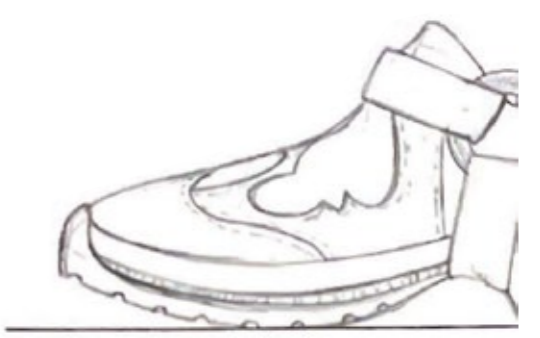



GAITER  
LEG WARMER

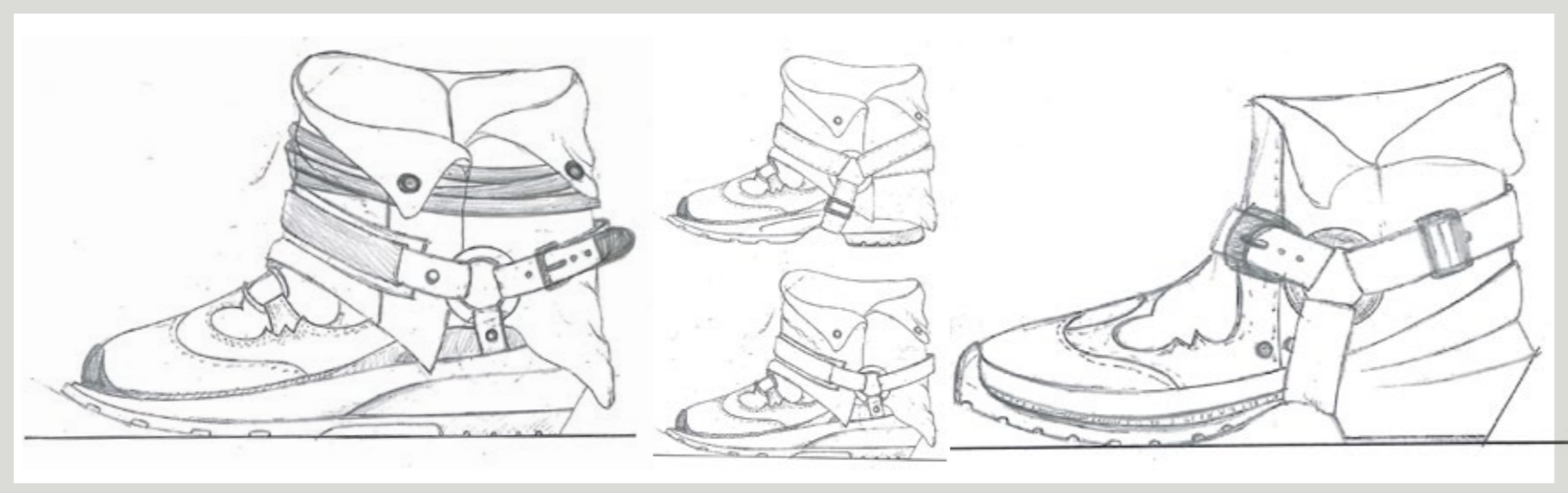
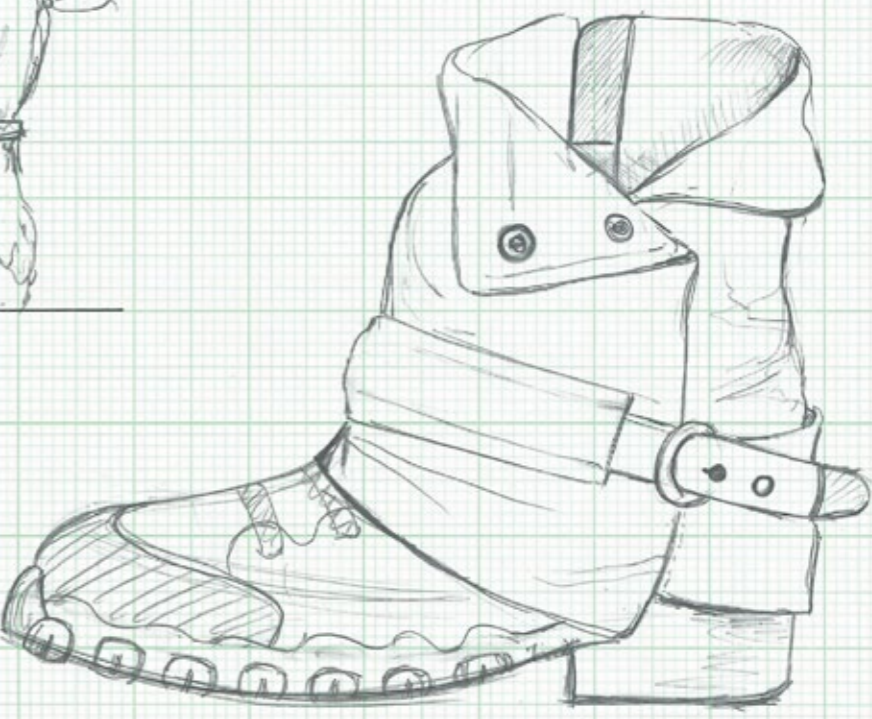
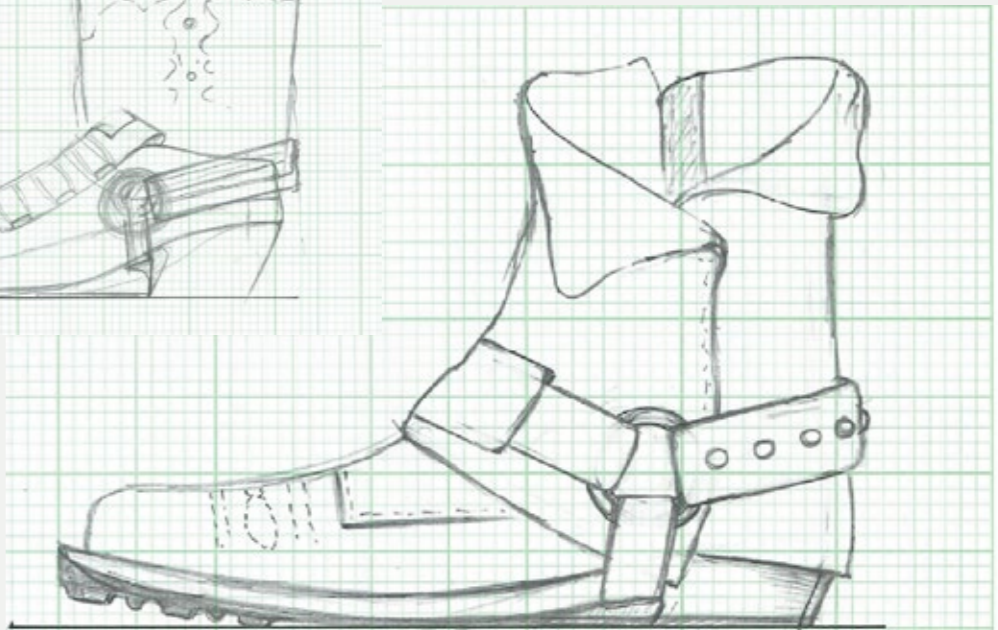
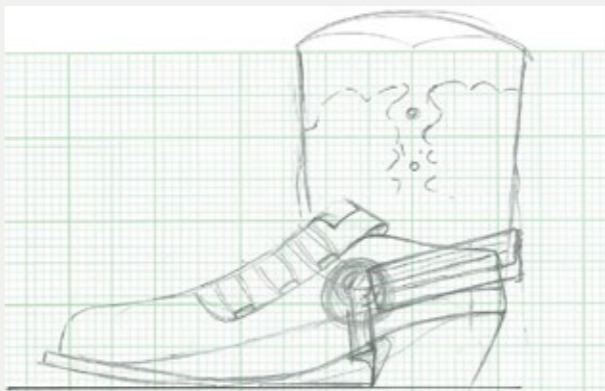

# Design Development 3

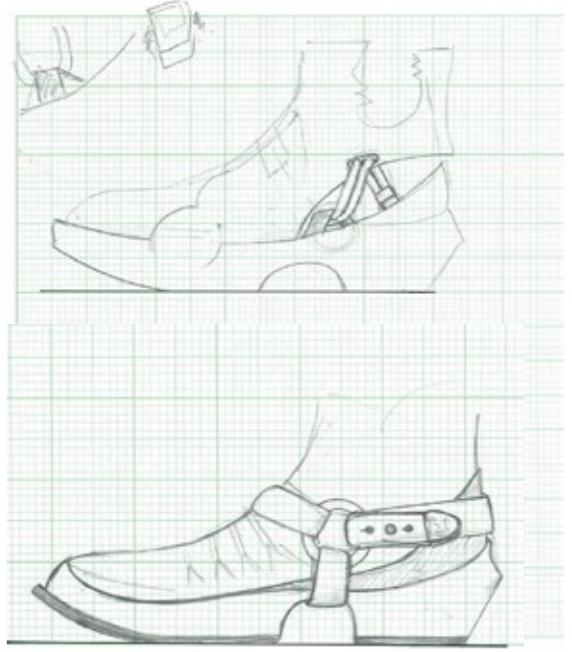
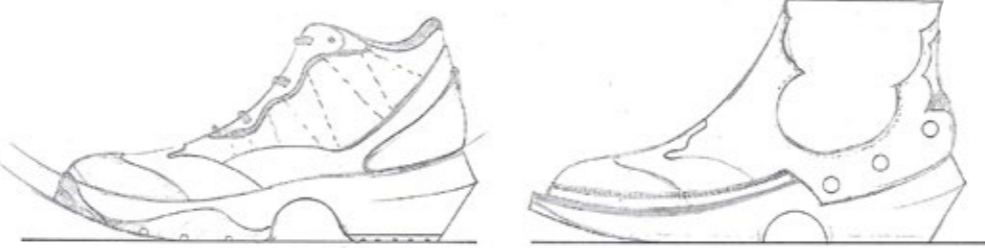
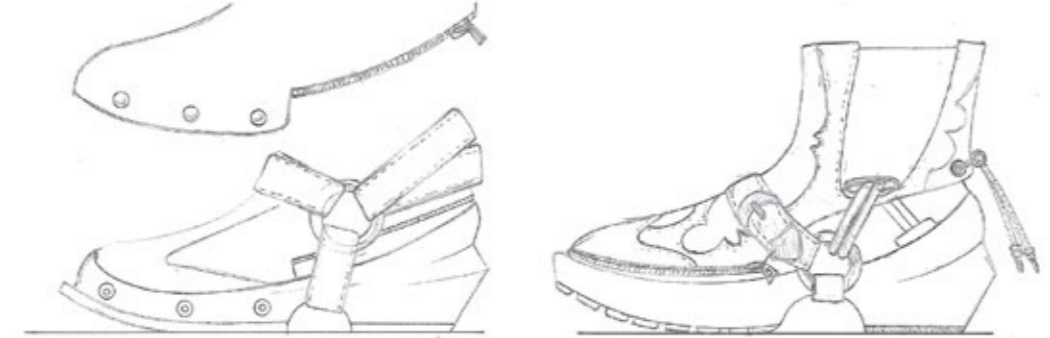
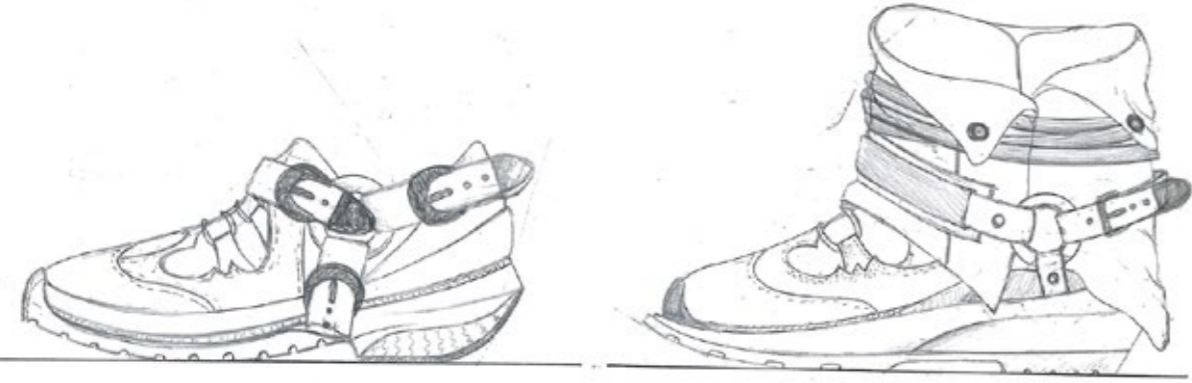
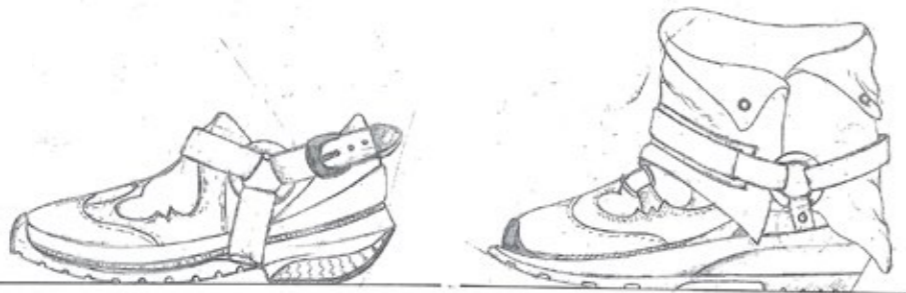
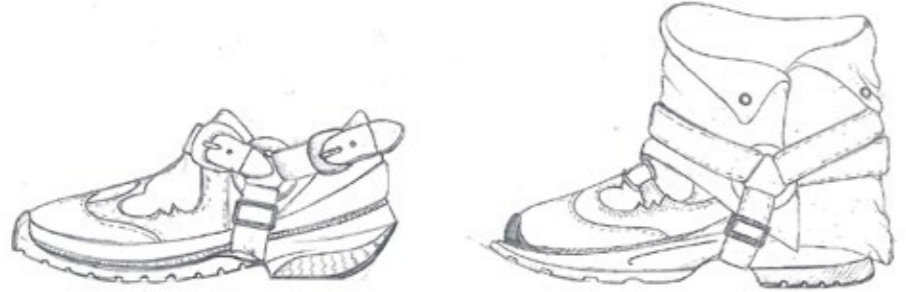
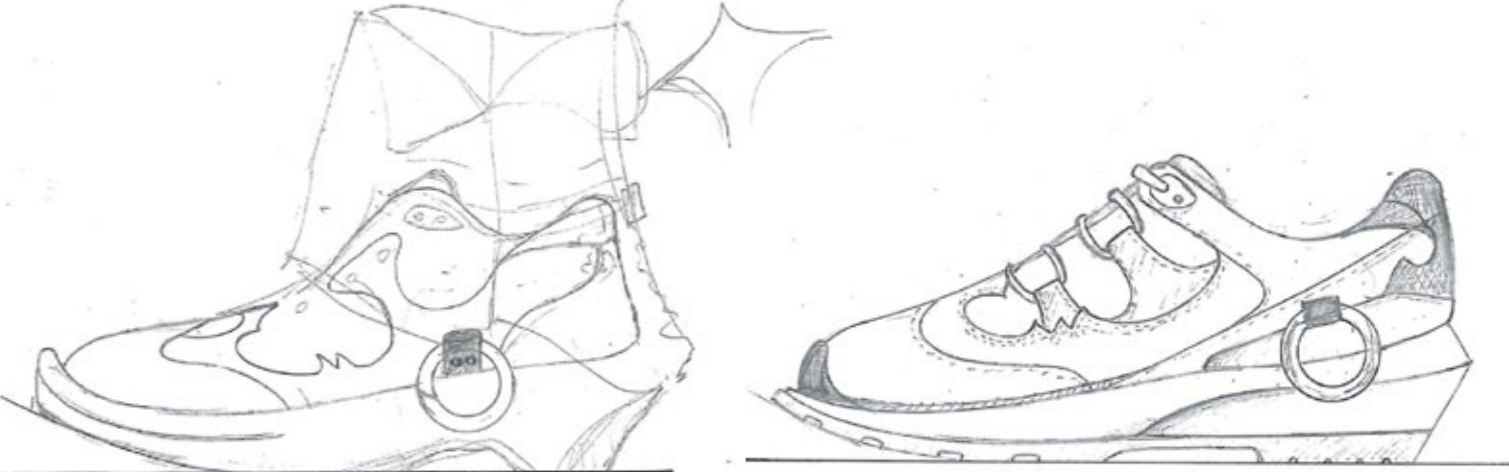
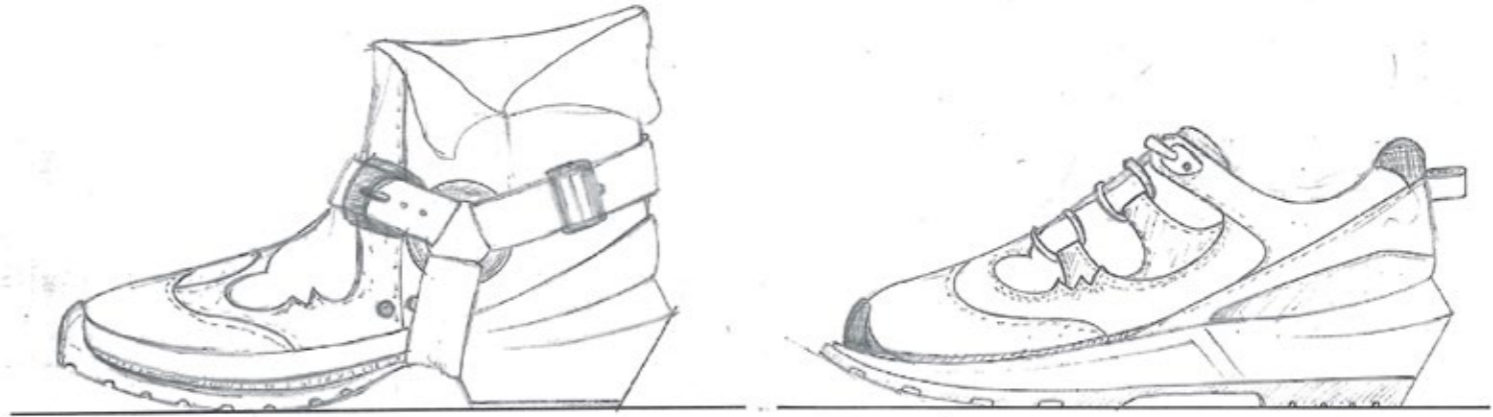

# Design Development 4

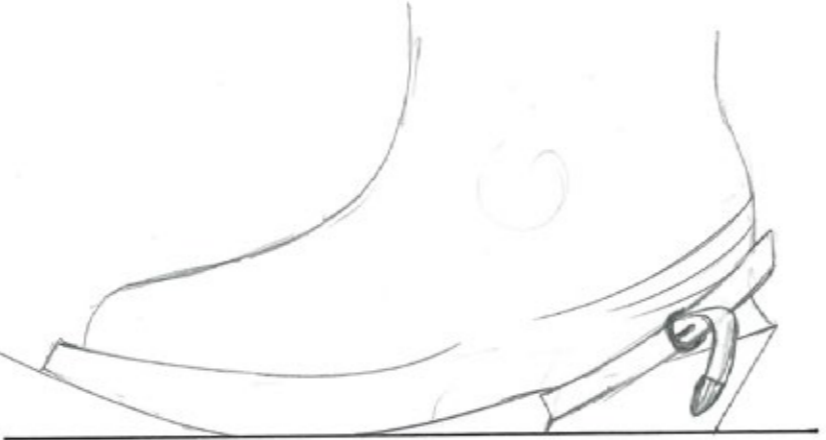
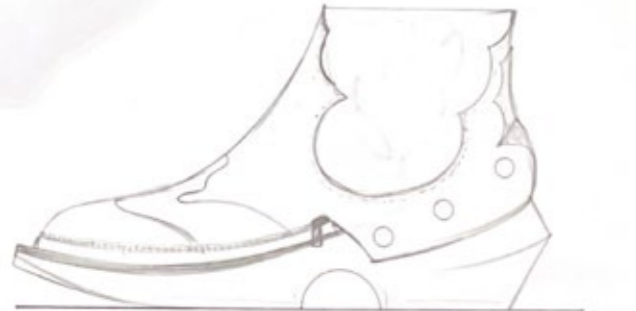
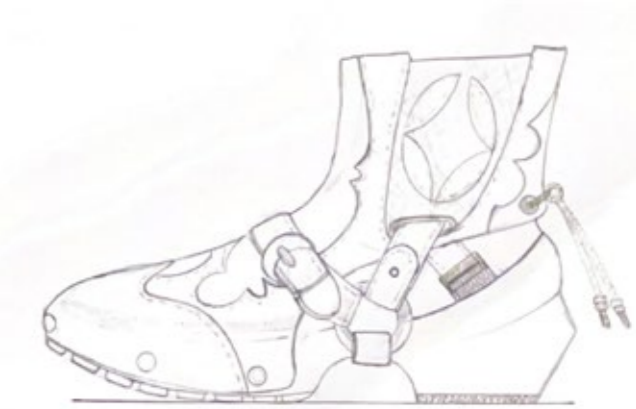

# Design Development 5



I made mack-up with soft and thin leather to see the shape and wrinkles which would be shaped nicely. And I checked my patterns either which was what I imagined.



Put an elastic band to control warist and making some wrinkles.

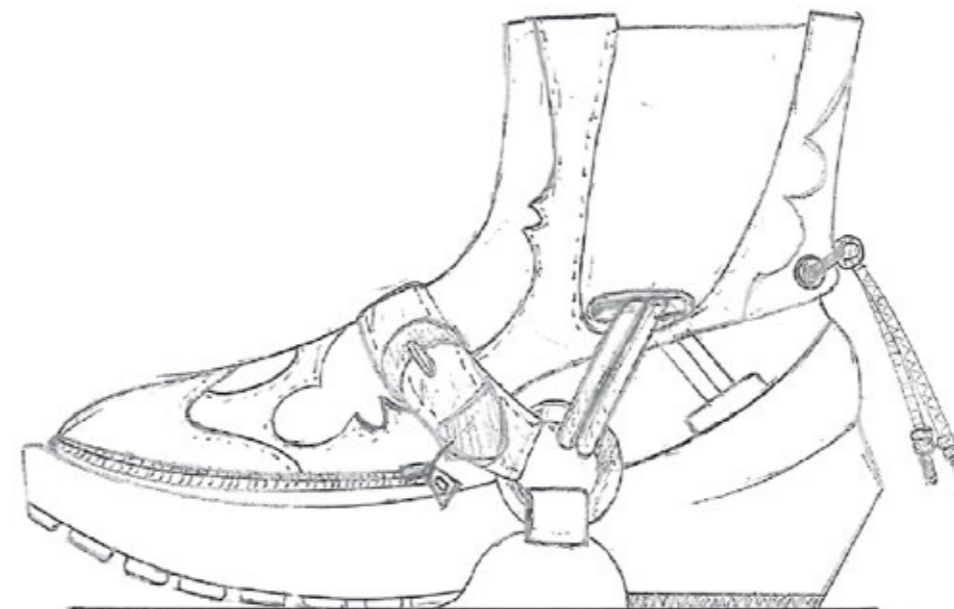
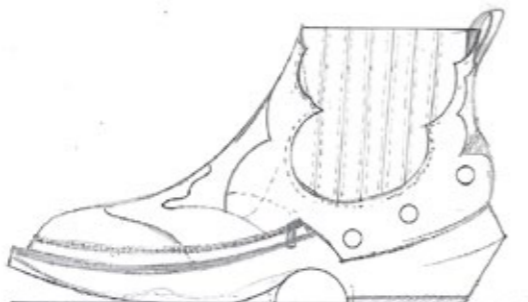
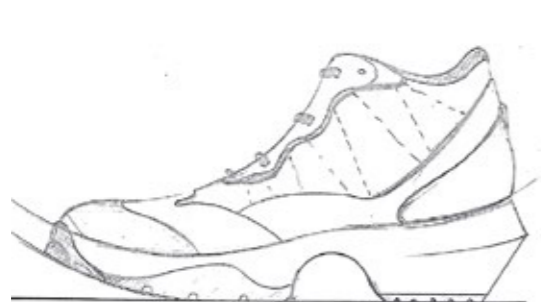

I made 2nd make up with real cow leather. This leather is looks good but it is to hard to do lasting and blocking. I needed to find the way.





# Design Development 6



Blocking the leather to make toe cap.

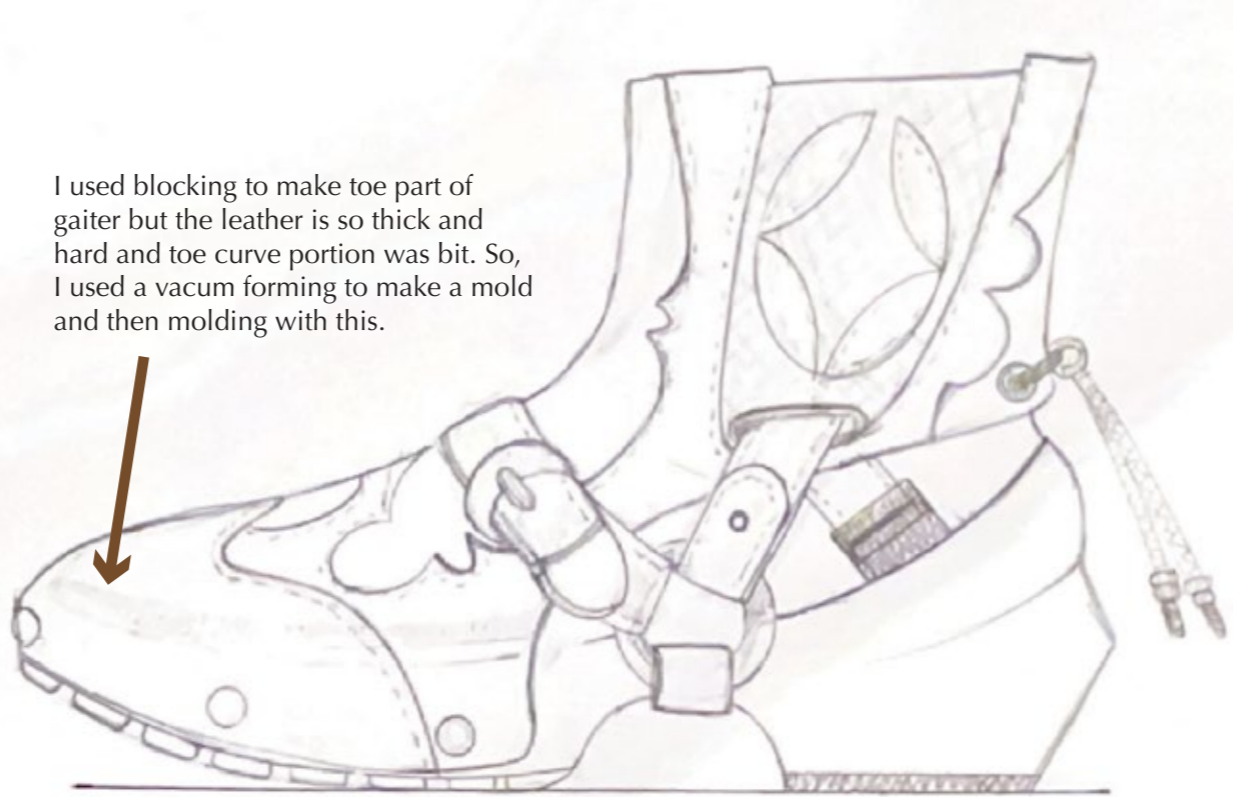

I used blocking to make toe part of gaiter but the leather is so thick and hard and toe curve portion was bit. So, I used a vacuum forming to make a mold and then molding with this.



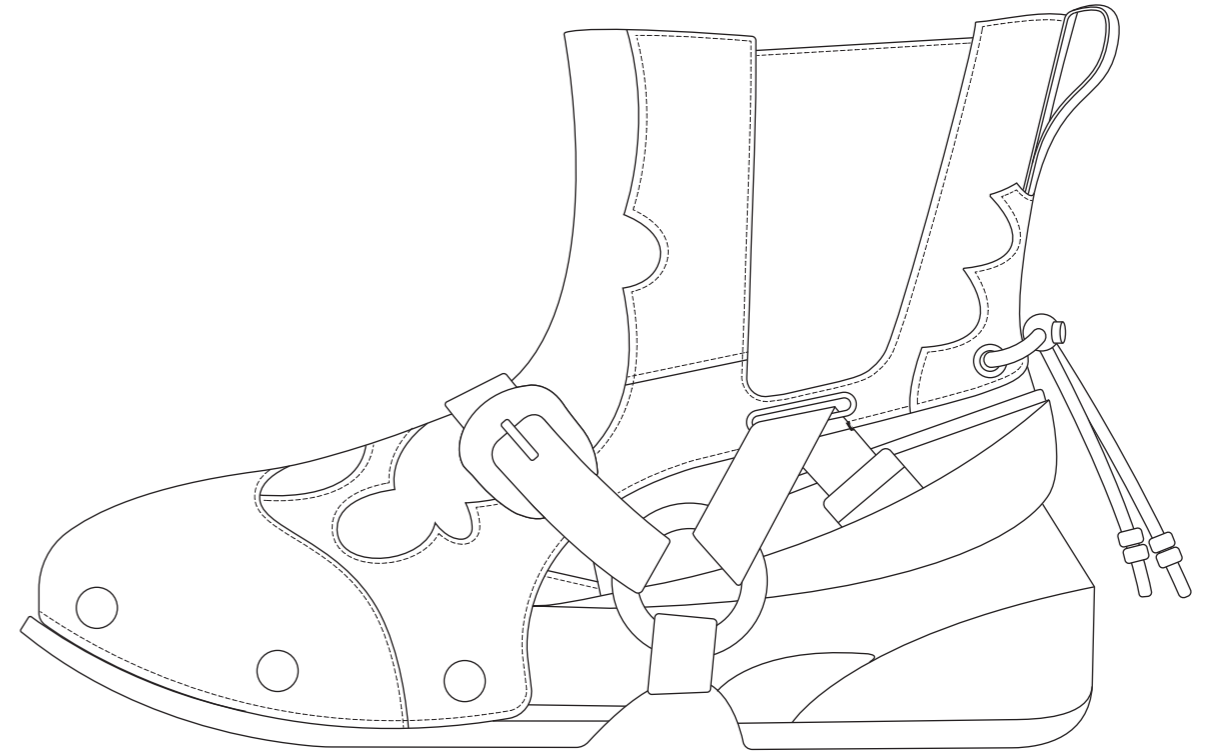

LINE DRAWING

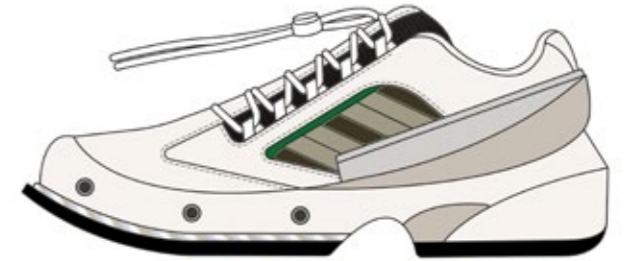

COLOUR RANGE

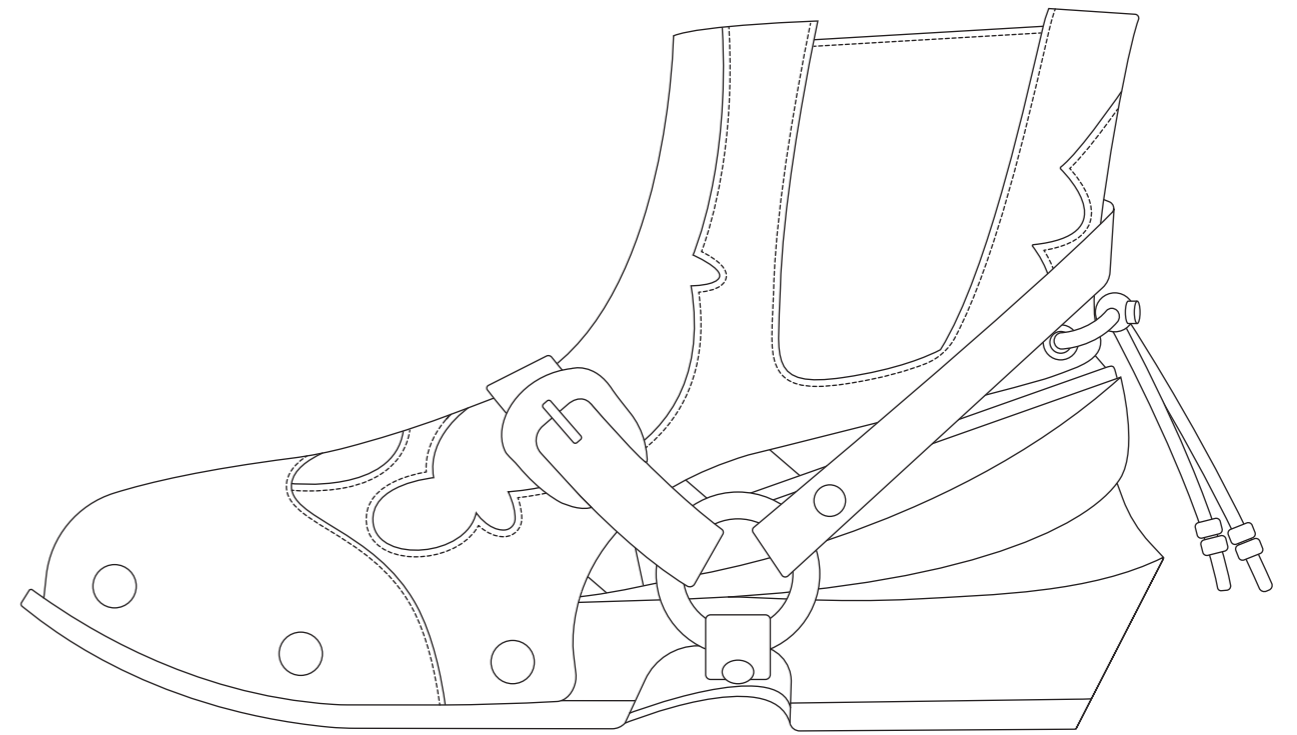

LINE DRAWING



COLOUR RANGE

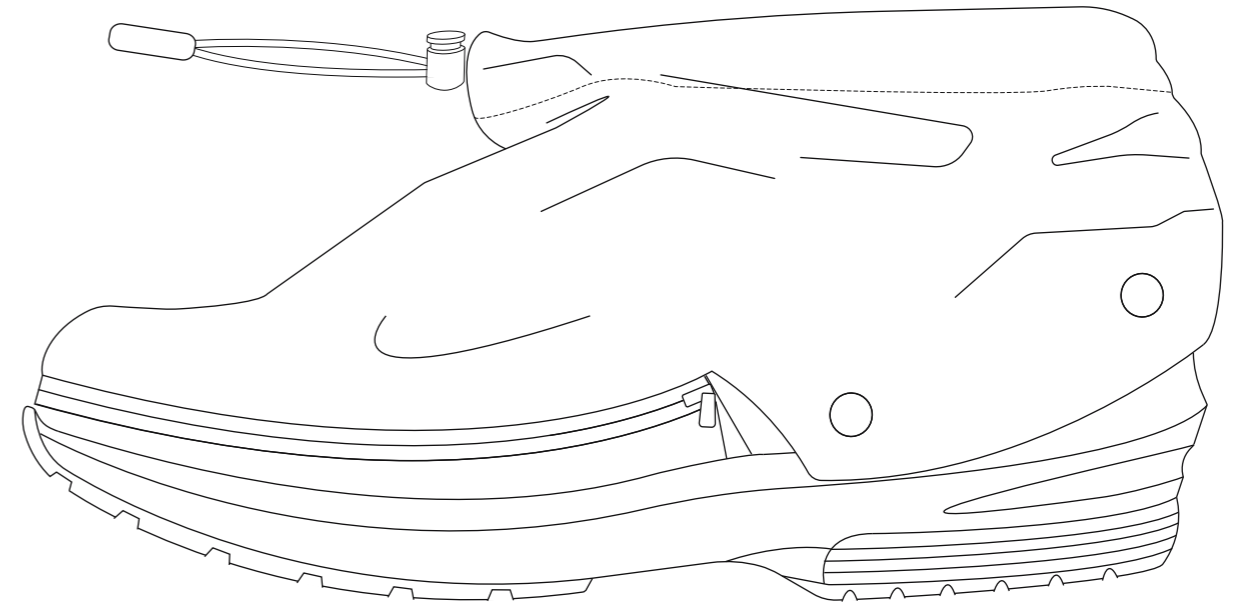

LINE DRAWING



COLOUR RANGE

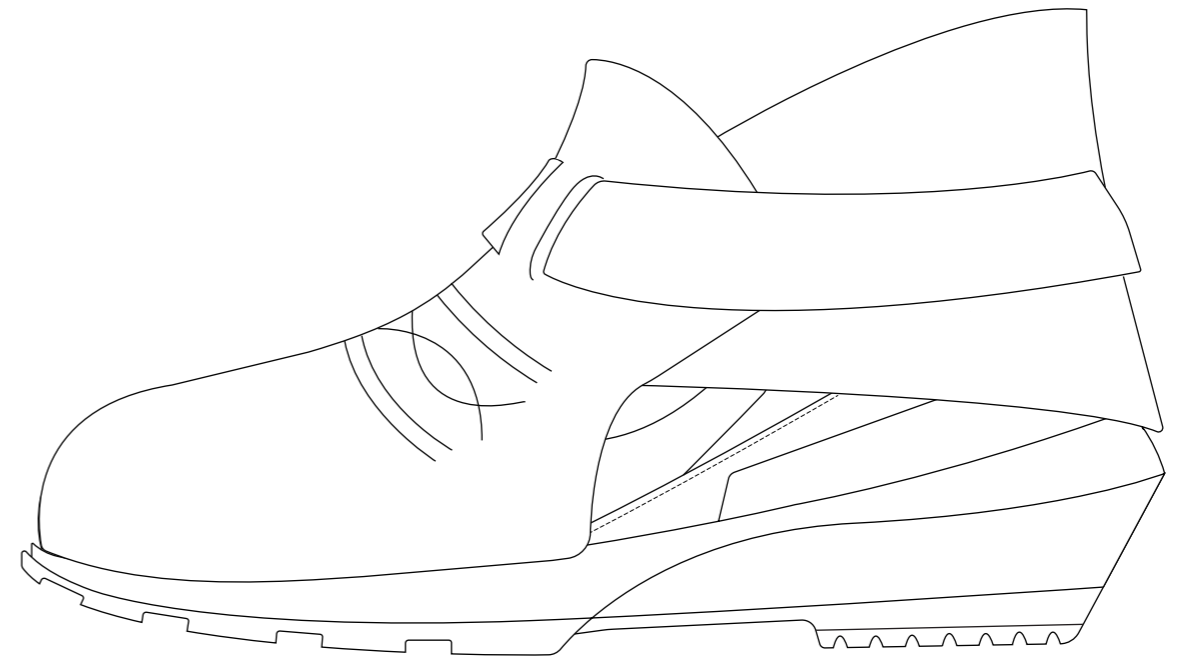

LINE DRAWING



COLOUR RANGE

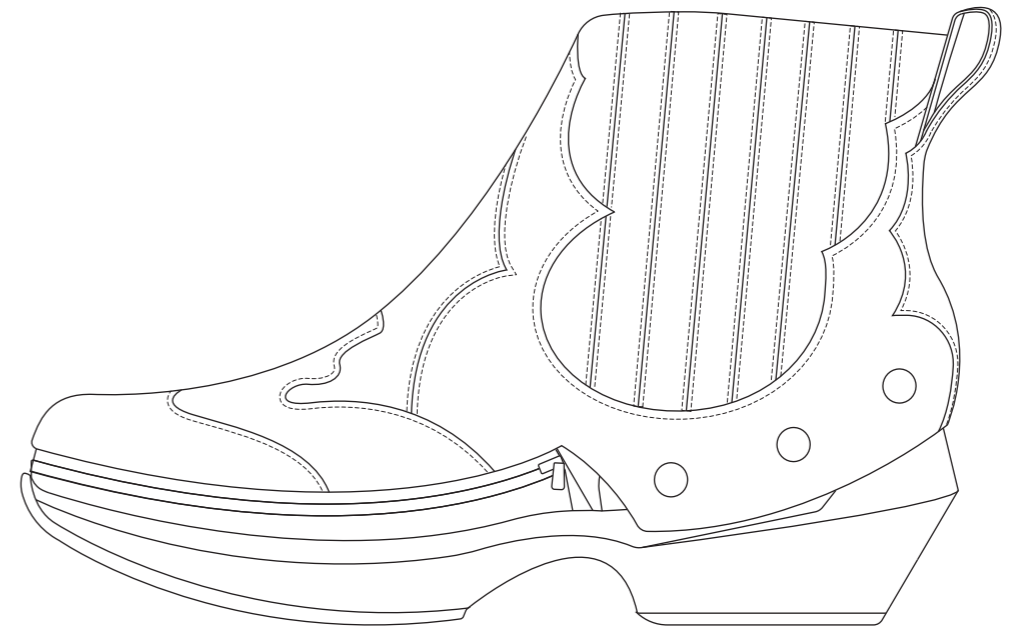

LINE DRAWING



COLOUR RANGE

**FINAL LINE UP**

**F/W2023 COLLECTION**



SHOE COMPONENTS

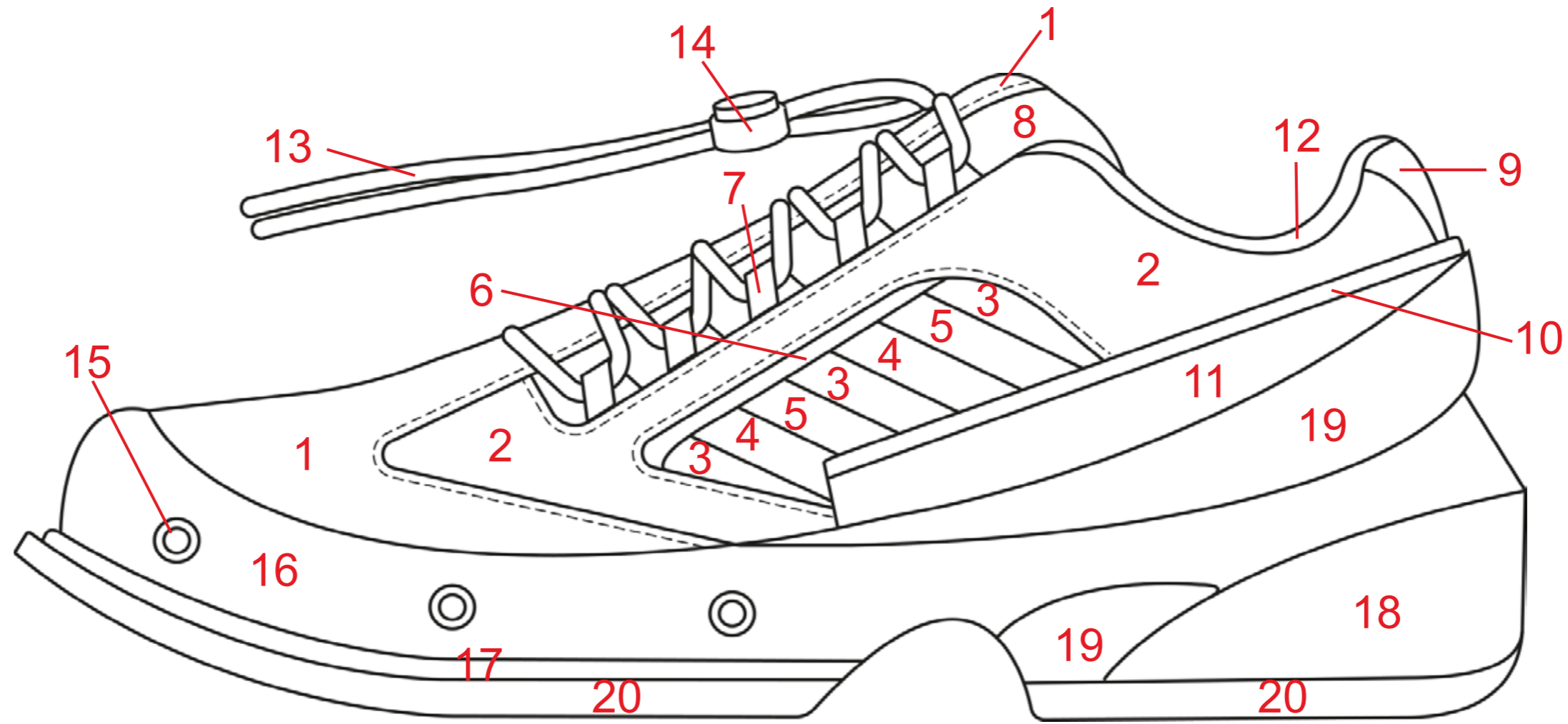

TIP	VAMP	QUARTER	QUARTER DECORATION	WEBBING EYELETS	TONGUE	COLLAR	ZIPPER	ZIP GUARD
1	2	3 4 5	6	7	8	9	10	11
COLLAR LINING	SHOE LACE	CORD LOCK	SNAP FASTENER	MIDSOLE	MIDSOLE DECO ROPE	FLARED HEEL	CONTOURED MIDSOLE	OUTSOLE
12	13	14	15	16	17	18	19	20



FW23

STYLE:RUNWAY  
LAST:MHP39 SL4955

CATEGORY: SPORTS SHOE  
SAMPLE SIZE: 8



PROJECT TYPE: Quagga Project  
PROTOTYPE: QUICK SPEC  1ST  CFM

DATE: 18 NOV 2022

DESIGNER: Woosung Kim  
DEVELOPER: Woosung Kim

## SHOE MATERIALS AND COLOURS



TIP	VAMP	QUARTER	QUARTER DECORATION	WEBBING EYELETS	TONGUE	COLLAR	ZIPPER	ZIP GUARD
SHELL CORDOVAN BLACK C	NUBUCK LEATHER DARK KHAKI	3 4 5	LEATHER DARK GREEN	WAVED FABRIC BLACK C	MESH BLACK C	SHELL CORDOVAN BLACK C	Black Open Ended Plastic Zipper	WAVED FABRIC BLACK C
COLLAR LINING	SHOE LACE	CORD LOCK	SNAP FASTENER	MIDSOLE	MIDSOLE DECO ROPE	FLARED HEEL	CONTOURED MIDSOLE	OUTSOLE
MESH BLACK C	Round Black 3.5mm	Black 		Black EVA	Black and Beige Twisted Rope 	Grey EVA	Black EVA	Black Rubber

MATERIALS AND COLOURS

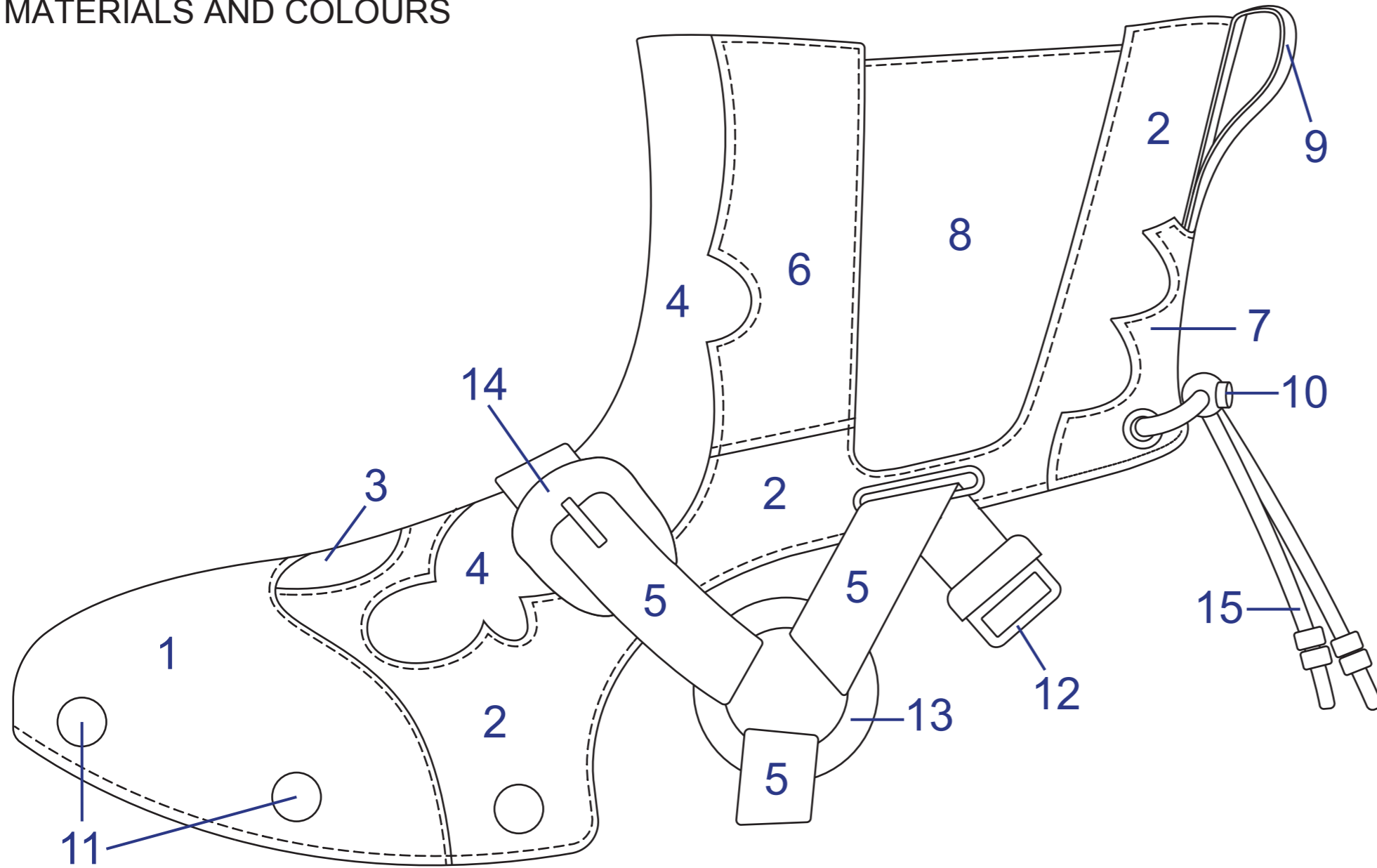

HARDWEAR IMAGES

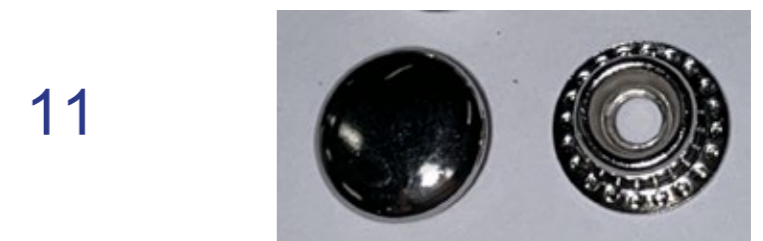

1	2	3 4	5 6 7	8	9
Black Shells Cordovan Leather 1-1.2mm	Black Shells Cordovan Leather 1-1.2mm	Black Full Grain Calf 0.8mm	Black Shells Cordovan Leather 1-1.2mm	Black Full Grain Calf 0.8mm	Black Shells Cordovan Leather 1-1.2mm
10	11	12	13	14	15
Black Plastic Spring Loaded Round Toggle Stopper Cord Locks	Silver Snap Fastener 11mm	Black Coated Metal Snap Clasp Buckle	Silver Metal O Ring Heavy Duty Seamless Molded Solid Round Ring 50mm Inner Diameter	Rusted Silver Metal Buckle 30mm Inner Diameter Check Ref. image	Beige / Brown Rope Lace with Knot at the Edge

# OUTSOLE

This standard is for size 8

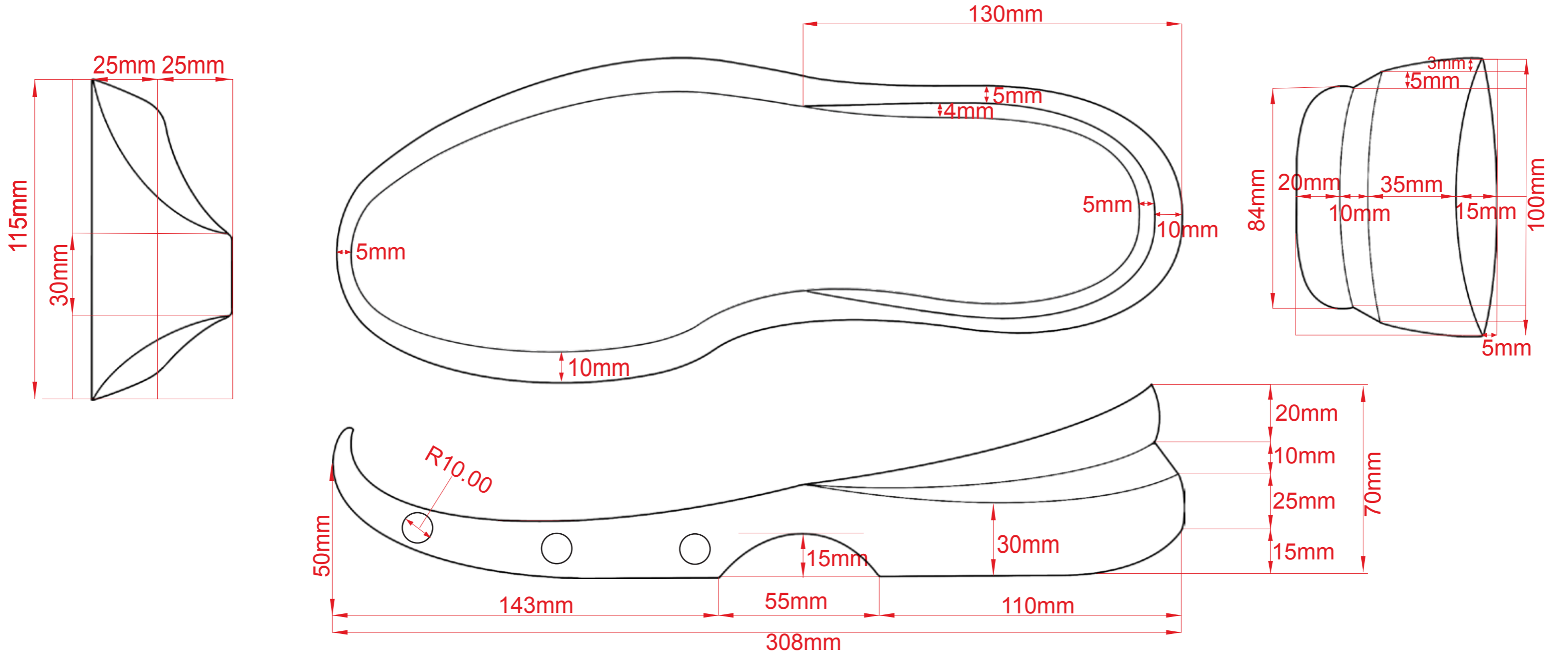

# PROTOTYPE

