

International Real Leather Competition 2023

Cameron Collins
Savannah College of Art and Design

Moodboard



Color & Trend Brainstorming

Trend Concept:
Bold Minimalism

Inspiration:

- Rattle Snakes
- Tree Bark
- Neutrals
- Earth Tones
- Asymmetry
- Organic Shapes



Thumbnails

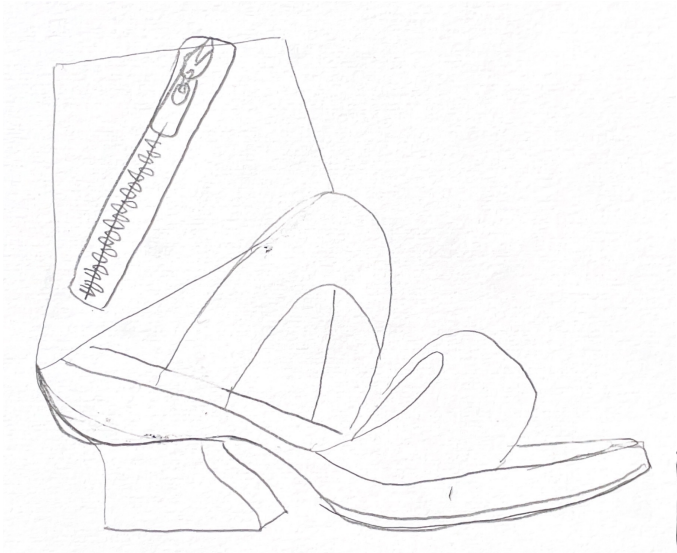

Description

My goal is to make a women's ankle boot that is modern but also versatile, sustainable, and durable.

This silhouette is inspired by bold minimalism and asymmetry. The color palette is from nature and earth tones, particularly rattlesnakes and trees.

I used research from the Better Shoes Foundation to focus on sustainable materials. I would use FSC-certified wood for the heel. The FSC (Forest Stewardship Council) is a global, non-governmental organization advancing ethical forest management. I would use cactus leather for the lining and sock liner. Cactus leather is a vegan leather substitute by a Mexican company, Desserto, derived from nopal cactus. It grows solely from rainwater and is PETA certified. For the foam padding, I would use Bloom Algae. Rise by Bloom is an algae-blended resin that can be used for sheet foam, injection foaming, and compression molding and has a renewable content of 40%. For the zipper I chose stainless steel due to this metal's durability. The sole would be fair trade rubber.



DESSERTO®



BETTER SHOES FOUNDATION

International Student Design Competition

Cameron Collins

S/S 2023

Style: Women's Ankle Boot

Size: US 5 UK 3 EU 36

Upper

Cattle Hide Dark Brown (Full Grain)

Lining & Sock Liner

Cactus Leather White

Heel

FSC-Certified Wood (Stained)

Zipper

Stainless Steel

Thread - Self Color

Sole

Fair Trade Rubber



ZIPPER

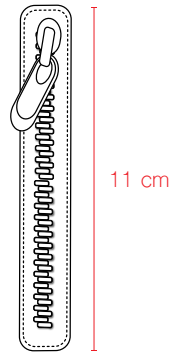

OUTSIDE

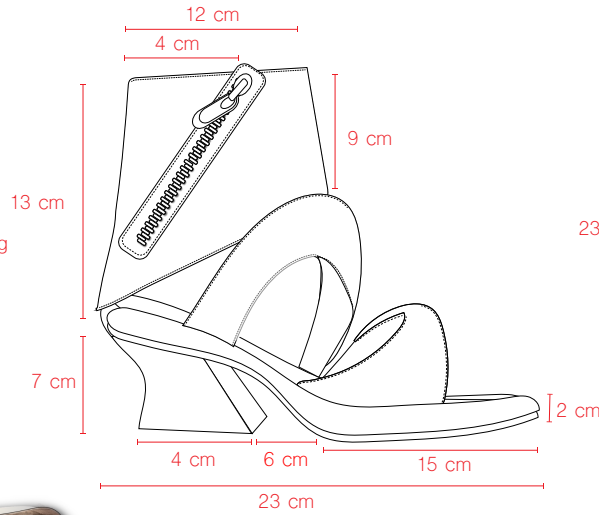

TOP

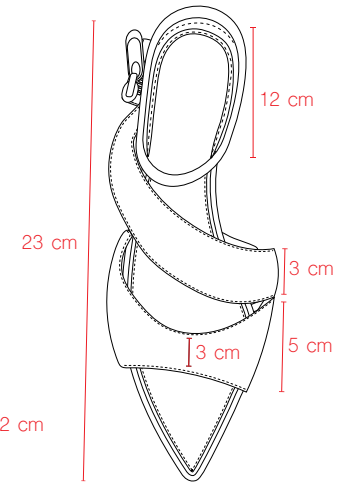

BOTTOM

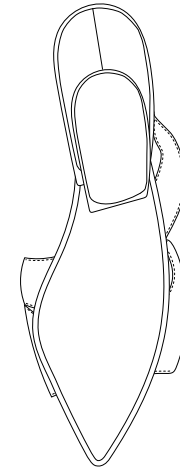

INSIDE

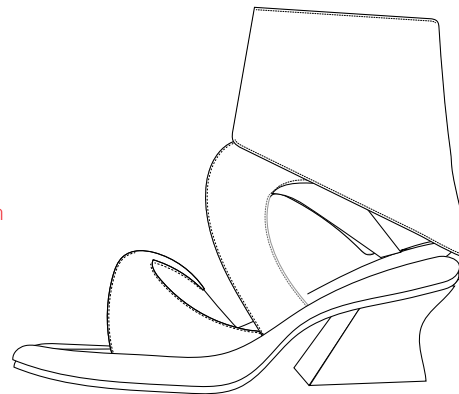

FRONT

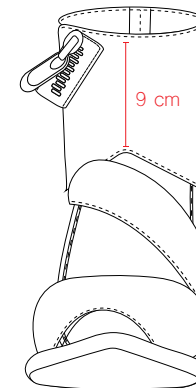

BACK

